



SLD1268-T V1

12.1" TFT LCD, LED Backlight 2000nits,XGA(1024x768)

SLD1268-T is an innovative sunlight readable, LED backlight LCD display. It provides LCD panel with specific ratios for digital signage, public transportation, exhibition hall, department store, vending machine and industrial applications. Incorporating with AD. Control board and backlight design, it is high brightness and sunlight readable panel, can display high-quality video with energy-efficient.

Key Features

- Wide Operation Temperature
- High Brightness 2000 nits
- Sunlight Readable
- LED Backlight
- Low Power Consumption
- Slim Bezel
- BL MTBF: 100,000 hours



Specifications

V1

Model No.	SLD1268-T V1
Description	12.1" TFT LCD, LED Backlight 2000nits, 1024x768
Display Area (mm)	245.8(H) x 184.3(V) mm
Bezel Size (U/B/L/R)	9.15/8.3/12.4/10.6 mm
Brightness	2000 cd/m ²
Resolution	1024x768 (XGA)
Contrast Ratio	1000 : 1
Pixel Pitch (mm)	0.24(H) x 0.24(V)
Pixel Pre Inch (PPI)	106
Viewing Angle	160°(H),160°(V)
Color Saturation (NTSC)	60%
Display Colors	262K/16.2M
Response Time (Typical)	8ms
Sync	LVDS
Operating Temperature	-20°C to +70°C
Storage Temperature	-30°C to +80°C
Power Consumption	13.8W
Dimensions (mm)	272x205.4x36.2 mm
Weight (Net)	1.0Kg
LED Driving Board	LID12A
Control Board	AD6038GD (VGA+DVI)
F / R Control Button	4 Key
<input type="checkbox"/> 4 Key	Power Switch, Menu, Select (+,-),
OSD Menu	Brightness, Contrast, H/V Position, Color, Phase, Clock...

SLD= Panel+ LED Driving Board + Control Board + Housing

Specifications are subject to change without notice. I

All brands or product names are trademarks or registered trademarks of their respective companies.



Mechanical Drawing

Outline Dimensions

Unit: mm

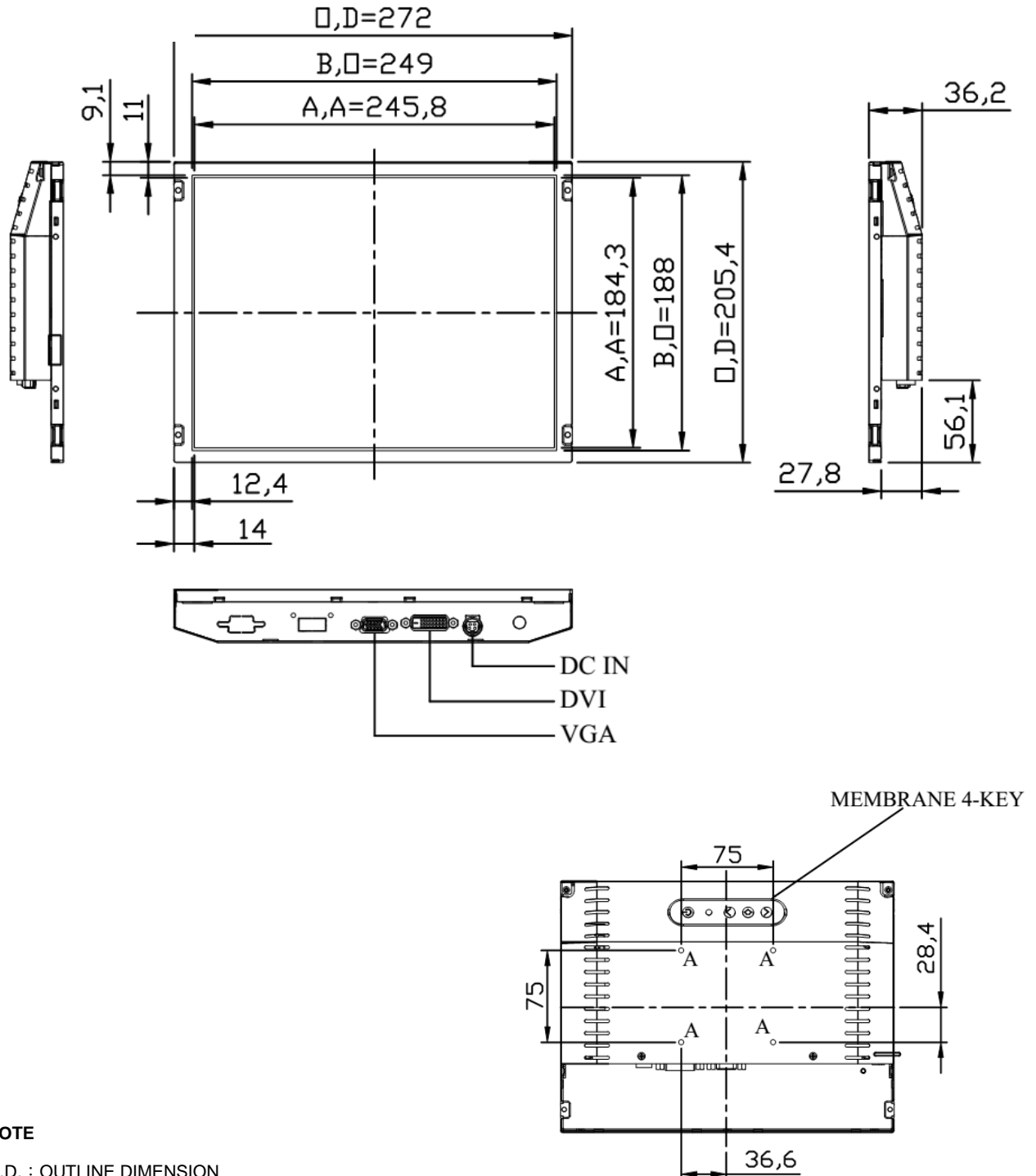

NOTE

O.D. : OUTLINE DIMENSION

B.O. : BEZEL OPENING

A.A. : LCD ACTIVE AREA

A:4-M4_USER HOLE_MAX_DEPTH=4mm



Ordering Information

Part Number	Description
SLD1268-TNB-I51	12.1",2000nits,XGA,LID12A,AD6038GD,O/B,DC12V,2in1,V1

Optional Accessories

Part Number	Description
840612031101	ADAPTER.12V.3.33A.40W.G99-KPL040F-N051.DC Plug 2.1*5.5,P
810618301010	CABLE.POWER.AC.1830mm USA type
810618301090	CABLE,POWER,AC,1830mm Europe type
810618301050	CABLE.POWER.AC.1830mm UK type
810618301170	CABLE.POWER,AC,1830mm Australia type
810618301031	CABLE.POWER.AC.1830mm Japan type

By Customer Request

Touch	Resistive (Single-Touch), SCT (Single-Touch), PCT (Multi-Touch)
AOT	Liquid Bonding, OCA Bonding
Glass	Tempered glass, AR coating.....
DC to DC Power Board	DC9~36V input